

Proudly Made  
In America



# Mx-OPUS-DRDHV

## IN-FIXTURE DALI NODE (POWERED BY 100-277 VAC)

### OVERVIEW:

The Mx-OPUS-DRDHV provides for bi-directional, fixture level wireless DALI (digital addressable lighting interface) lighting control integration. Mx-OPUS-DRDHV receives incoming signals from wireless EnOcean devices and converts them into DALI commands, allowing for both occupancy based lighting control and daylight harvesting functionality. The Mx-OPUS-DRDHV can be paired with a variety of sensors and switches for standalone operation, incorporated into a networked lighting system or integrated to BACnet utilizing the Mx-EBOX gateway.

### DESCRIPTION:

The Mx-OPUS-DRDHV is powered by 100 to 277 VAC and includes a built in DALI Bus power supply of 10mA at 14VDC. The Mx-OPUS-DRDHV includes 4 individual, configurable channels. Each channel includes full range dimming, customizable scene control, built in dawn control, adjustable ramping speeds and adjustable rate of dimming.

### OPTIONS IN OPERATION:

**Local Control:** An on board microprocessor and memory allows for standardized operation at the fixture level, eliminating the reliance on software or network configuration. Mx-OPUS-DRDHV can be utilized out of the box with default settings or configured for advanced operation through AirConfig software ([download.magnumes.net](http://download.magnumes.net)) by leveraging the Magnum wireless USB dongle (Mx-USB). Preferences and settings can be accomplished using simple drag and drop remote configuration in a localized fashion, even after the installation is completed.

**Software Driven:** The Mx-OPUS-DRDHV can also be used with Magnum's VenergyUI software, allowing users to control lighting with their mobile devices.

**Integration to BAS:** The Mx-OPUS-DRDHV has the ability to communicate through Magnum's eBox (Mx-EBOX) and into an existing building automation system (BAS). The convergence of lighting and building automation allows for granular information to be communicated to the BAS for improved operational efficiency.

\*Subject to change

**Magnum Energy Solutions, LLC**

43 Village Way Suite 209 - Hudson, OH 44236 - phone 330.656.9365 - fax 330.656.9368 - [www.magnumenergysolutions.com](http://www.magnumenergysolutions.com) - [info@magnumes.com](mailto:info@magnumes.com)



Proudly Made  
In America

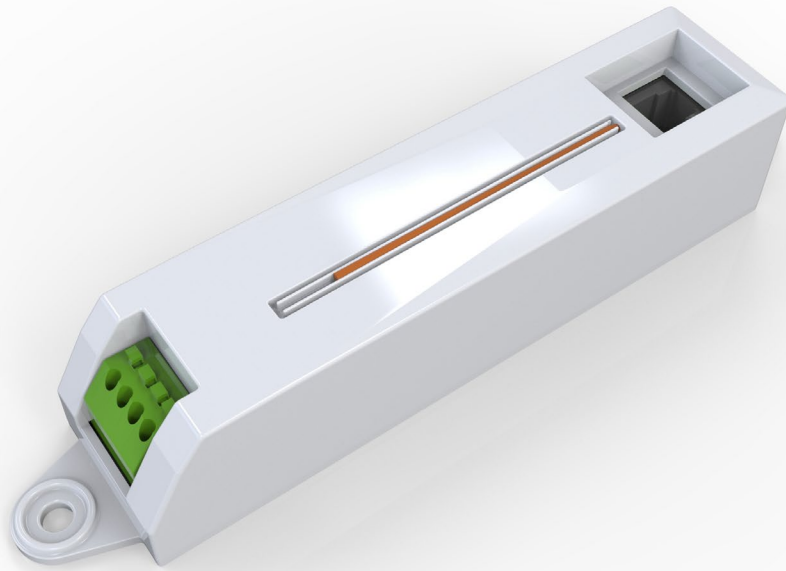

# Mx-OPUS-DRDHV

## IN-FIXTURE DALI NODE (POWERED BY 100-277 VAC)

### FEATURES:

- DALI Compatible
- Address up to 4 individual channels
- Mounts conveniently to driver
- Powered by 100-277 VAC
- Built-in DALI Bus power supply
- Connection for optional motion / lux sensor
- Energy reporting at fixture level (if driver is compatible)

### TECHNICAL DATA:

Part Numbers (Frequency Dependant)	<b>M9-OPUS-DRDHV</b> - 902 MHZ (standard for North America) <b>M8-OPUS-DRDHV</b> - 868 MHZ (Europe and China) <b>MJ-OPUS-DRDHV</b> - 928 MHZ (Japan)
Input Voltage	100 / 277 VAC
Input Sensors	Digital Passive Infrared Sensor 0-1020 Lux Sensor
Output	Built-in DALI Bus Power Supply of 10mA @ 14VDC
Number of DALI Node Channels	4
Standby Power	< 1W
Operating Temperature	32° - 140°F (0° - 60°C) - Indoor use only
Wireless Protocol	EnOcean Wireless Protocol
EnOcean Profile	A5-38-08 central controller D2-29-06 status
Wireless Range	150 ft (50 ft-150 ft typical) / 45.72 m (15.24 m - 45.72 m)
Certifications	IEC 62386-101:2014 IEC 62386-103:2014 DLC
Dimensions	L: 6.14" x W: 1.2" H: 1.10" (L: 155.956 mm x W: 30.48 mm x H: 27.94 mm)

\*Subject to change

**Magnum Energy Solutions, LLC**





Proudly Made  
In America

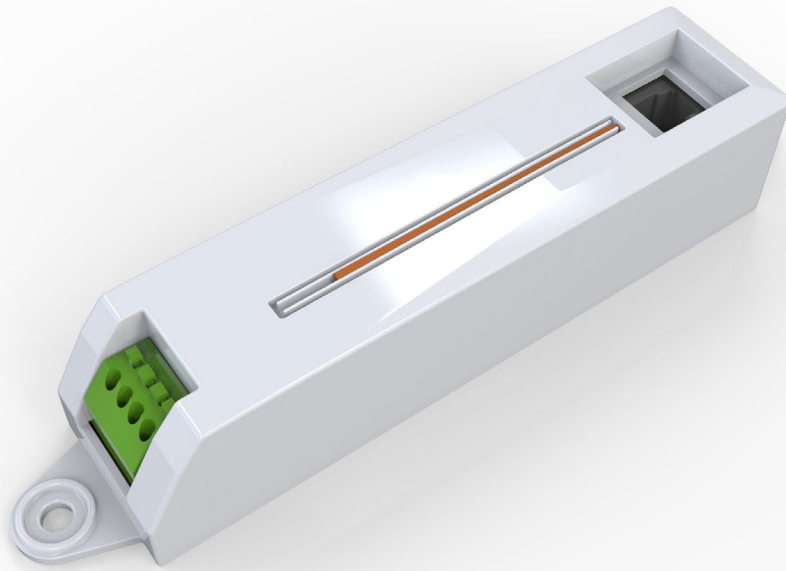

# Mx-OPUS-DRDHV

IN-FIXTURE DALI NODE (POWERED BY 100-277 VAC)

## DIMENSIONS:

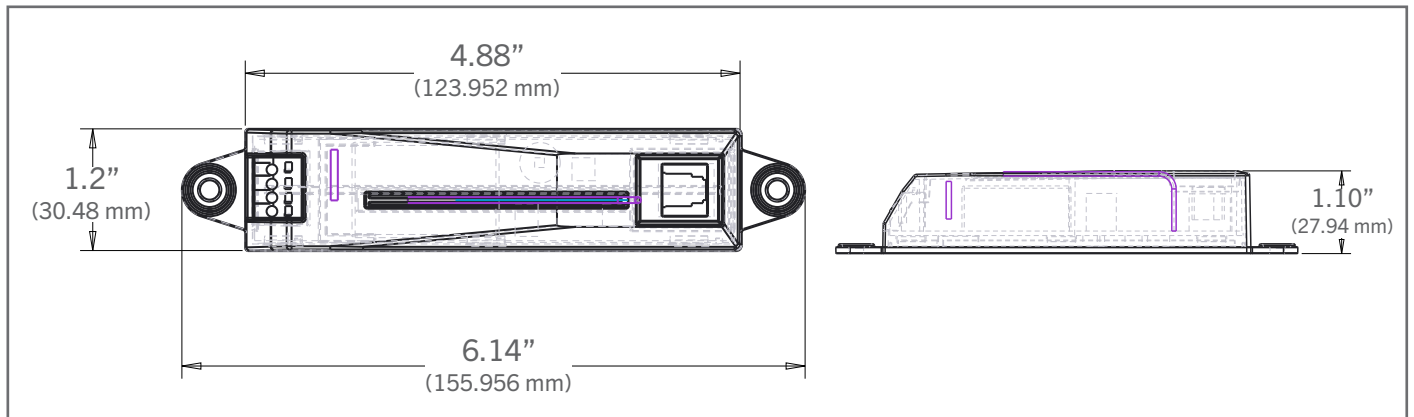

## WIRING DIAGRAM:

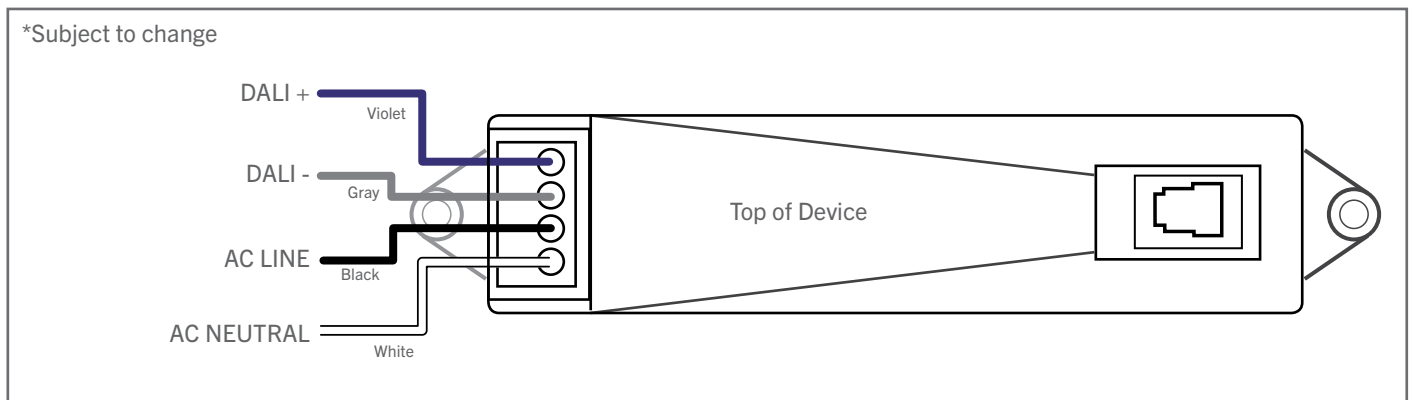

\*Subject to change

**Magnum Energy Solutions, LLC**



Proudly Made  
In America

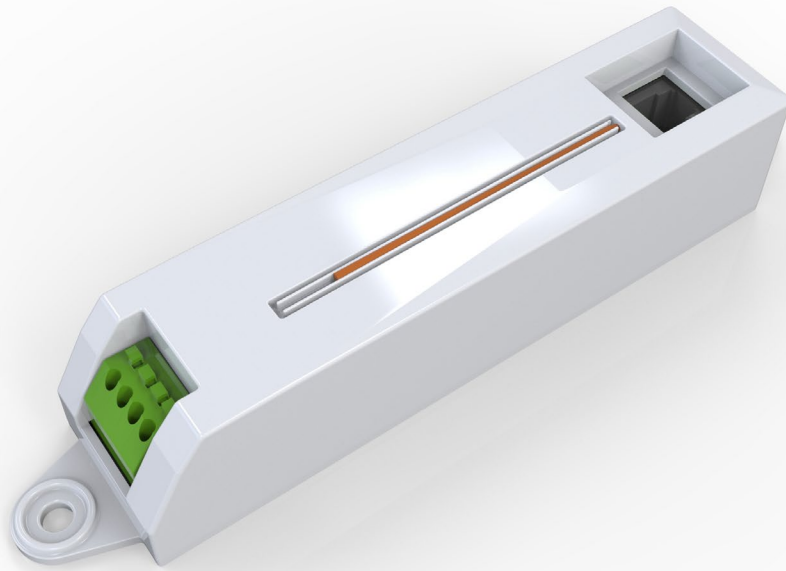

# Mx-OPUS-DRDHV

IN-FIXTURE DALI NODE (POWERED BY 100-277 VAC)

## OPTIONAL WIRED MOTION COMBINED LUX SENSOR:

This product has an optional motion combined LUX sensor that is connected to the controller via a simple 3-wire connector. The separate sensor is optional and is available for both high bay sensing (up to 39 feet) and for standard, low ceiling applications (up to 15 feet).

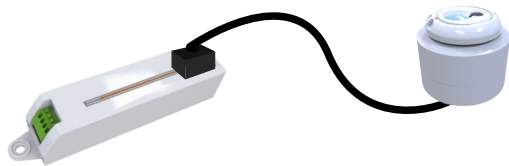

Mx-OPUS-LPML wired motion / lux sensor for  
low ceiling applications of up to 15 ft (4.572 m)

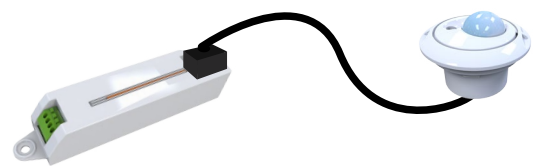

Mx-OPUS-HPML wired motion / lux sensor for  
high bay applications of up to 39 ft (11.887 m)

For tutorial videos regarding the OPUS product line, please visit MES on [YouTube](#).

\*Subject to change

**Magnum Energy Solutions, LLC**