

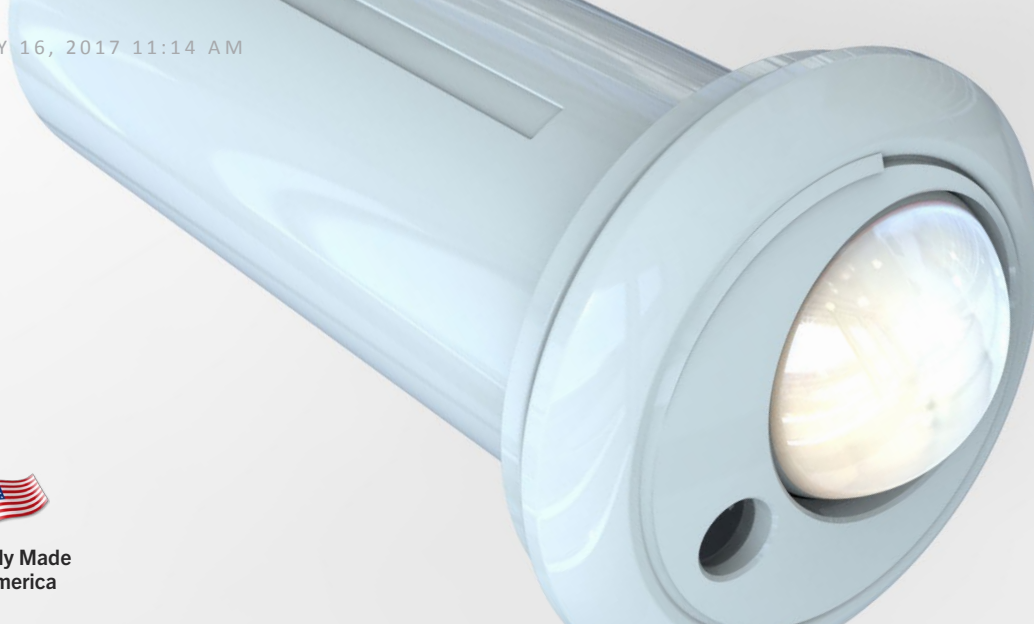

Proudly Made
In America



Mx-OPUS-CHML10V

FIXTURE INTEGRATED LIGHTING CONTROL

OVERVIEW:

Magnum's Fixture Integrated Mx-OPUS-CHML10V Node, when connected to a Philips Advance Xitanium SR LED driver, Osram OTI Dali driver or another compatible DALI driver, enables any lighting manufacturer to deliver simple standalone or fully connected fixtures. The small and sleek, cylindrical form factor includes a digital PIR sensor and ambient light sensing for daylight harvesting applications as well as occupancy based control. The Mx-OPUS-CHML10V can be powered by a driver fed auxiliary source if available or from any 10-36 VDC or 24VAC source. The Mx-OPUS-CHML10V allows for 0-10V dimming and dim-to-off functionality, providing continuous dimming control to conserve energy, simplify maintenance and personalize the lighting environment. Enhanced features include cascading as well as sequential and adjacent lighting schemes, available in completely standalone operation. Cascading allows for the capture of an "output" signal, such as occupancy, from one node to be utilized as an "input" signal to another node or multiple nodes. When integrated to a building system, software or to an IoT application, node data includes light status, occupancy status, lux values as well as energy reporting when utilized with a Philips SR driver or Osram OTI Dali driver. The Mx-OPUS-CHML10V is appropriate for fixtures up to 39 feet .

OPTIONS IN OPERATION:

Local Control: An on board microprocessor and memory allows for standardized operation at the fixture level, eliminating the reliance on software or network configuration. Mx-OPUS-CHML10V can be utilized out of the box with default settings or configured for advanced operation through Magnum's AirConfig software tool (download.magnumes.net). Preferences and behavior settings can be accomplished using simple drag and drop remote configuration in a localized fashion, even after installation is completed.

Software Driven: The Mx-OPUS-CHML10V can also be used with Magnum's VenergyUI software, allowing users to control lighting with their mobile devices.

Integration to BAS: The Mx-OPUS-CHML10V has the ability to communicate information through Magnum's eBox (Mx-EBOX) and into an existing building automation system. The convergence of lighting and building automation allows for granular information to be communicated to the BAS for improved operational efficiency.



*Subject to change

Magnum Energy Solutions, LLC

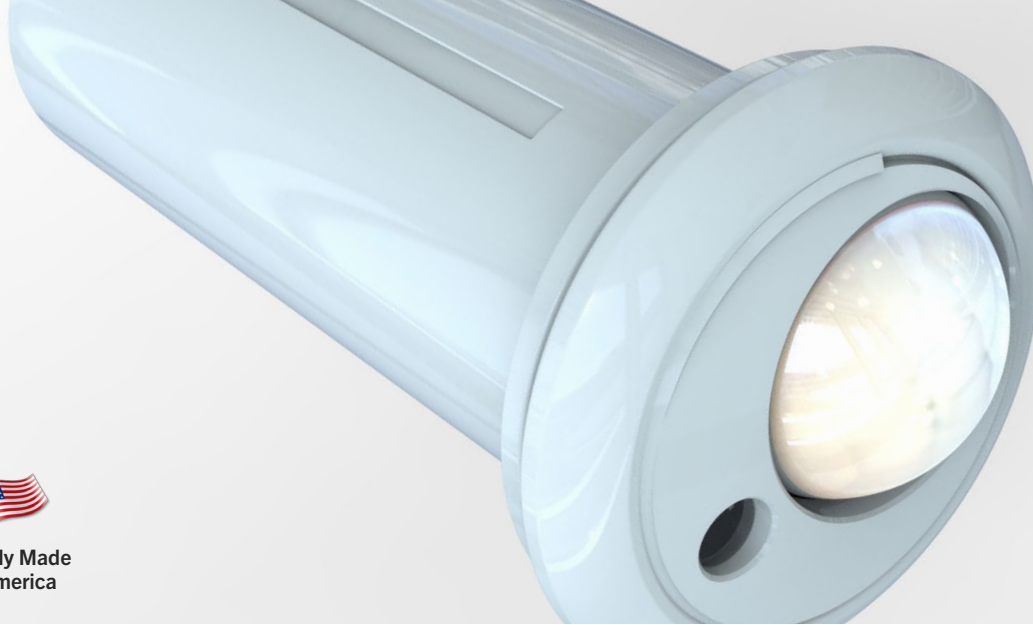

Proudly Made
In America

Mx-OPUS-CHML10V

FIXTURE INTEGRATED LIGHTING CONTROL

FEATURES:

- Full digital passive infrared for occupancy sensing
- Powered from driver or any available 12-36VDC / 24VAC source
- Wireless communication
- Daylight harvesting
- Compatible with 0-10V, dim-to-off LED drivers
- Remotely configurable

TECHNICAL DATA:

Part Numbers (Frequency Dependant)	M9-OPUS-CHML10V (902 MHz - North America) M8-OPUS-CHML10V (868 MHz - Europe & China) MJ-OPUS-CHML10V (928MHz - Japan)
Motion Sensing	Digital Passive IR
Detection Distance	12 m (39.3696 ft)
Detection Range (Horizontal x Vertical)	102° x 92°
Detection Zone	92 Zones
Ambient Light Sensing	0-94.8 FC (0-1020 LUX) Photo IC type
Operating Temperature	32° - 140°F (0° - 60°C) - Indoor use only
Input Voltage	12-36VDC / 24VAC
Output	0-10VDC @ 30mA (sinking driver) 5mA (sourcing driver)
Standby Power	< 1W
Enclosure	ABS Plastic
Wireless Protocol	EnOcean Wireless Protocol
Wireless Range	150 ft (50 ft to 150 ft typical)
Certifications	IEC 62386-101:2014 IEC 62386-103:2014
Dimensions	Tube diameter: 0.999" (25.37 mm) Catch diameter: 1.504" (38.20 mm) Cap diameter: 1.764" (44.81 mm) Tube length: 2.76" (70.10 mm)

*Subject to change



Proudly Made
In America

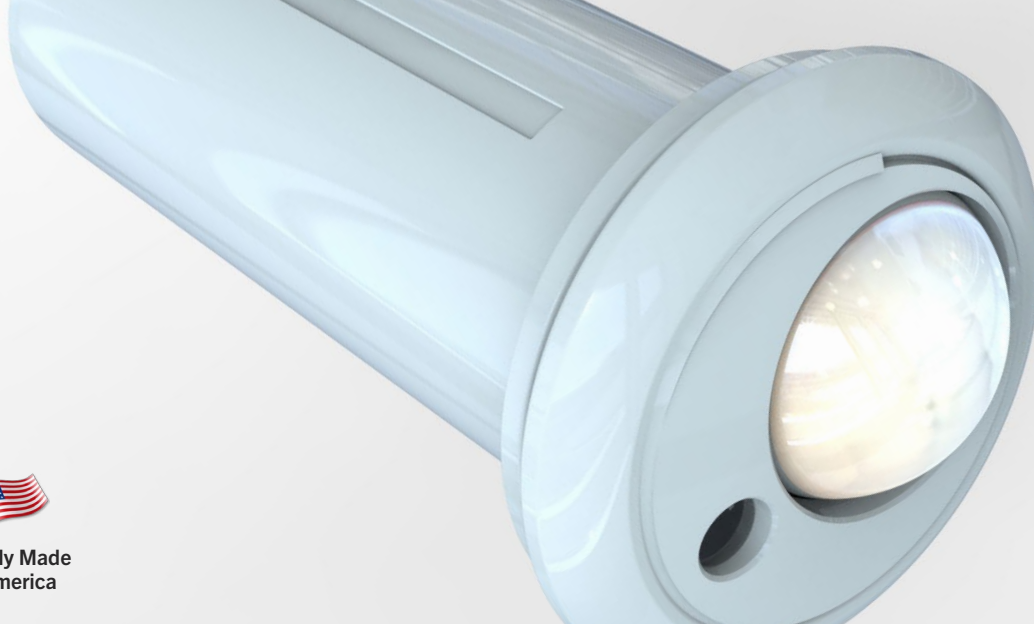

Mx-OPUS-CHML10V

FIXTURE INTEGRATED LIGHTING CONTROL

DETECTION PERFORMANCE:

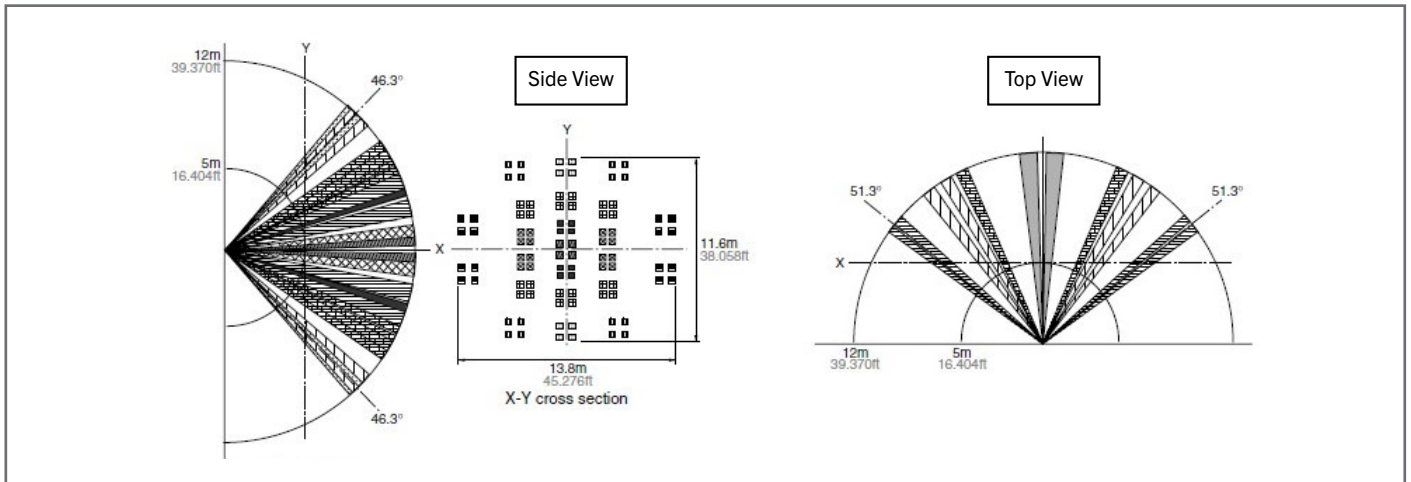

DIMENSIONS:

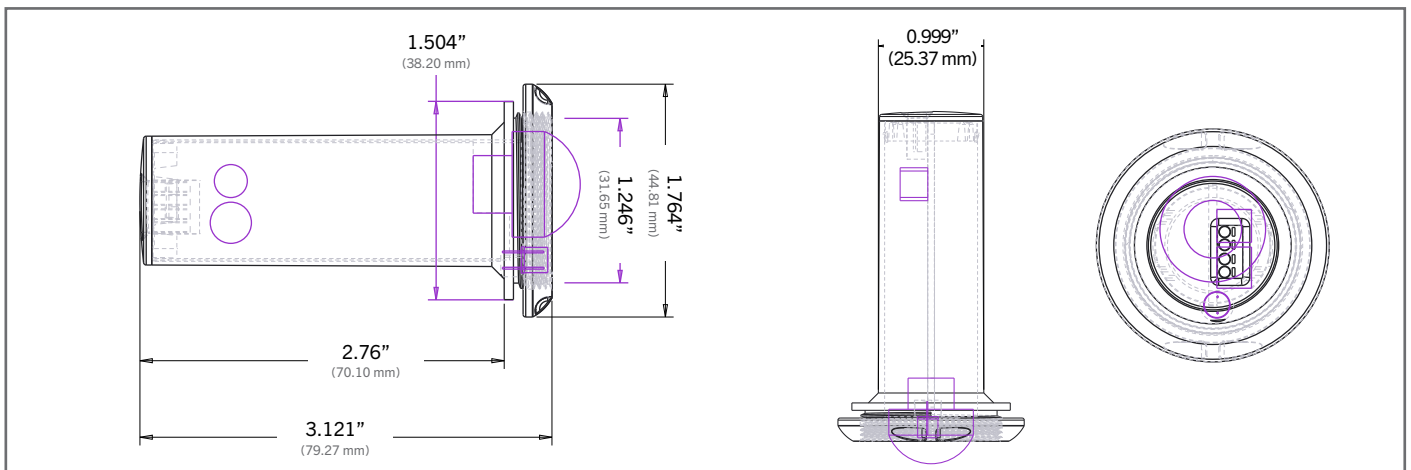

*Subject to change

Magnum Energy Solutions, LLC



Proudly Made
In America

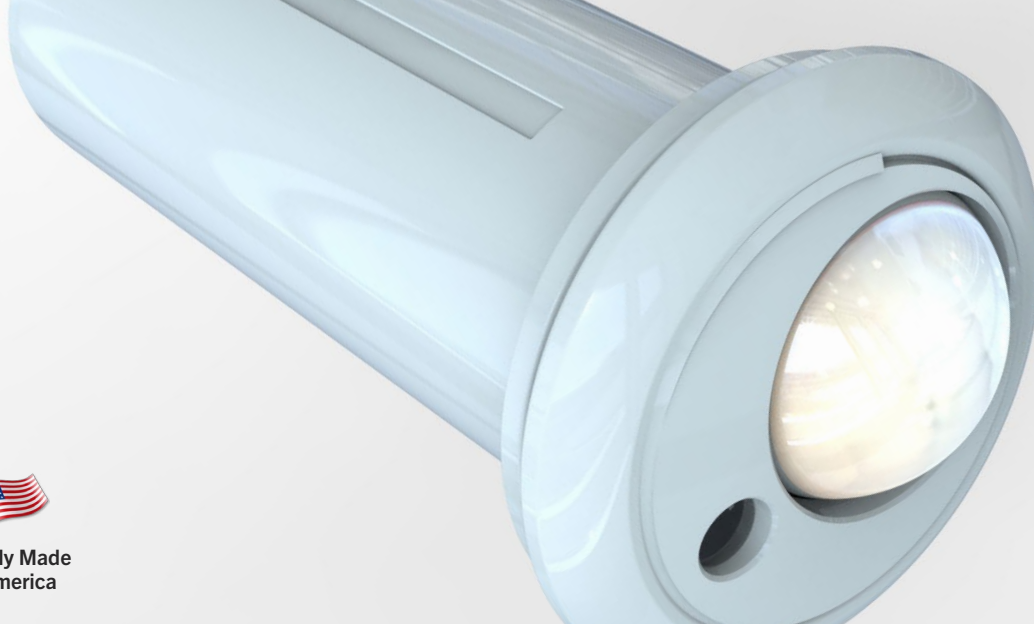

Mx-OPUS-CHML10V

FIXTURE INTEGRATED LIGHTING CONTROL

WIRING DIAGRAM:

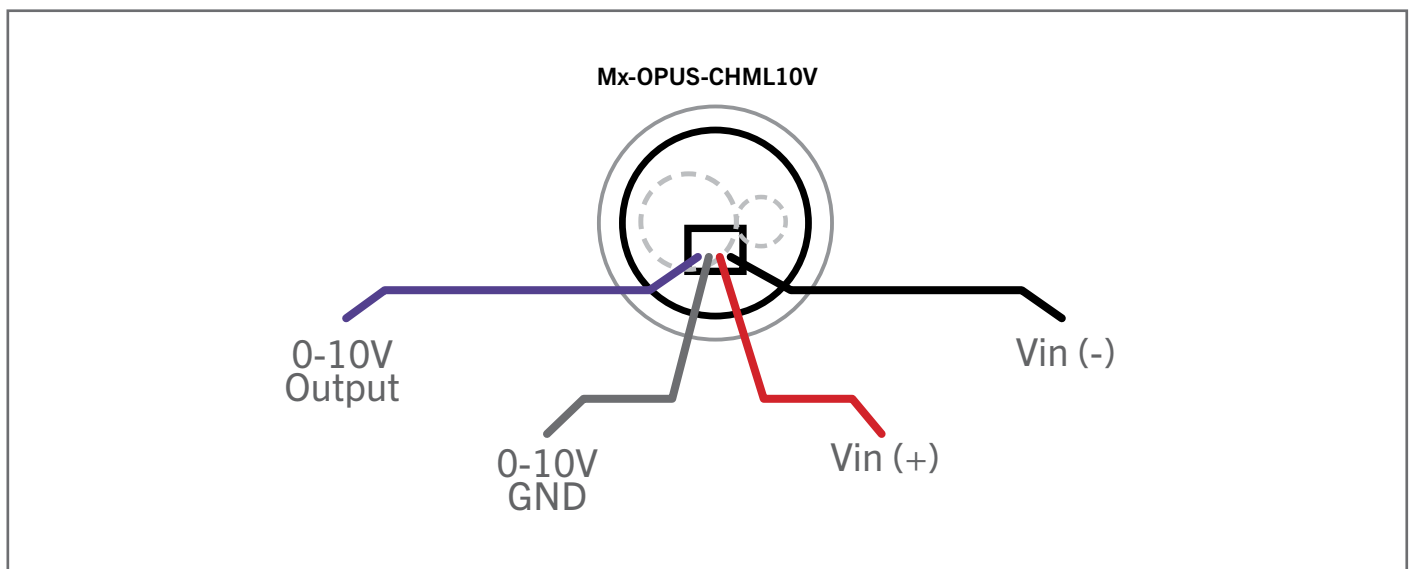

ENVIRONMENTAL CONCERNS:

- Humidity degree: 15 to 85%Rh (Avoid condensation or freezing of this product)
- Pressure: 86 to 106KPa
- Overheating, oscillations, shocks can cause the sensor to malfunction.
- This sensor is not waterproof or dust-proof. Avoid use in environments subject to excessive moisture, condensation, frost, containing salt air or dust.
- Avoid use in environments with corrosive gases.

For tutorial videos regarding the OPUS product line, please visit MES on [YouTube](#).

*Subject to change

Magnum Energy Solutions, LLC